

ARQUITECTURA ESPAÑOLA

SPANISH ARCHITECTURE

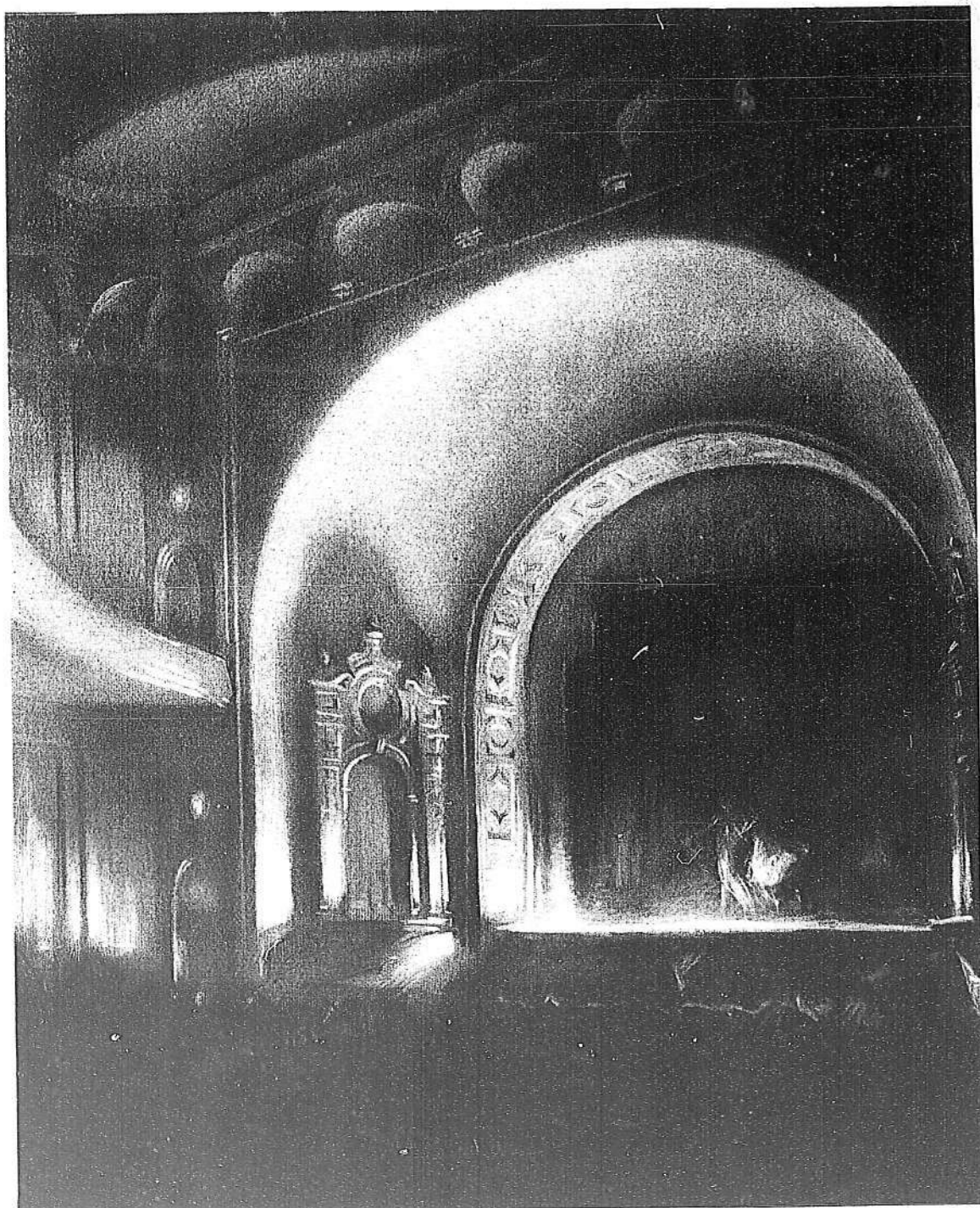

CASA DE LA PRENSA, MADRID

THE PRESS HOUSE, MADRID

PEDRO MUGURUZA, Arquitecto

AÑO VI, NÚM. XXIII, JULIO - SEPTIEMBRE MCMXXVIII

MADRID

Ayuntamiento de Madrid



Casa de la Prensa, Madrid
Fachada a la plaza del Callao

The Press House, Madrid
Front facing the plaza del Callao

PEDRO MUGURUZA, Arquitecto





Casa de la Prensa, Madrid

Sala de Fiestas y Estudios para mobiliario de la Asociación de la Prensa

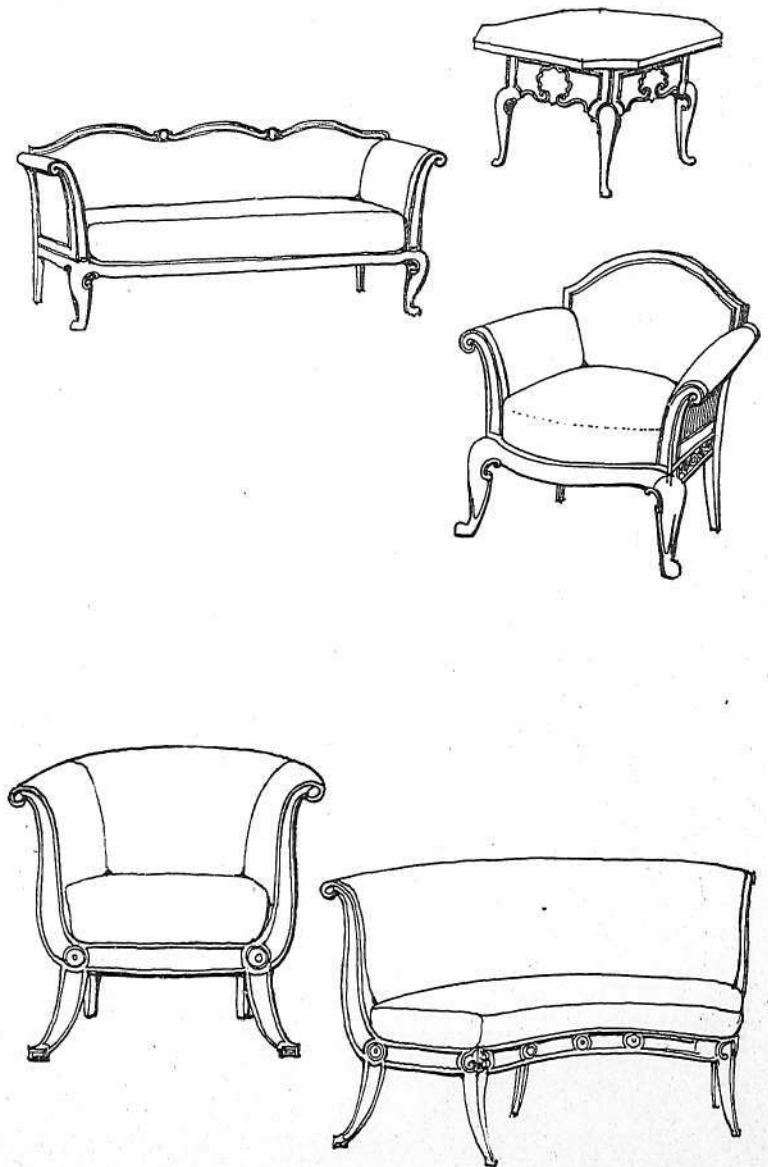

The Press House, Madrid

Festival Hall and Studies of furnishing scheme of Press Association



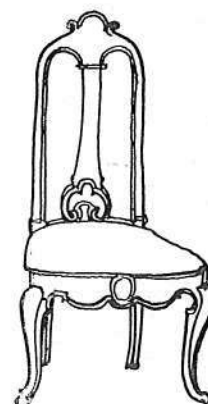
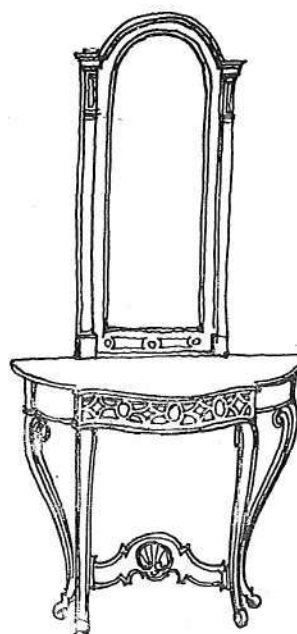
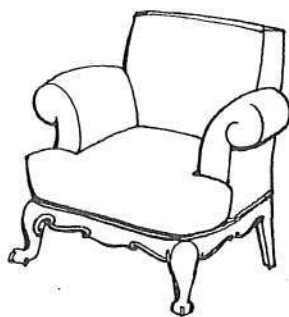
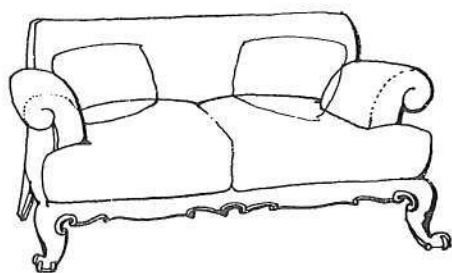
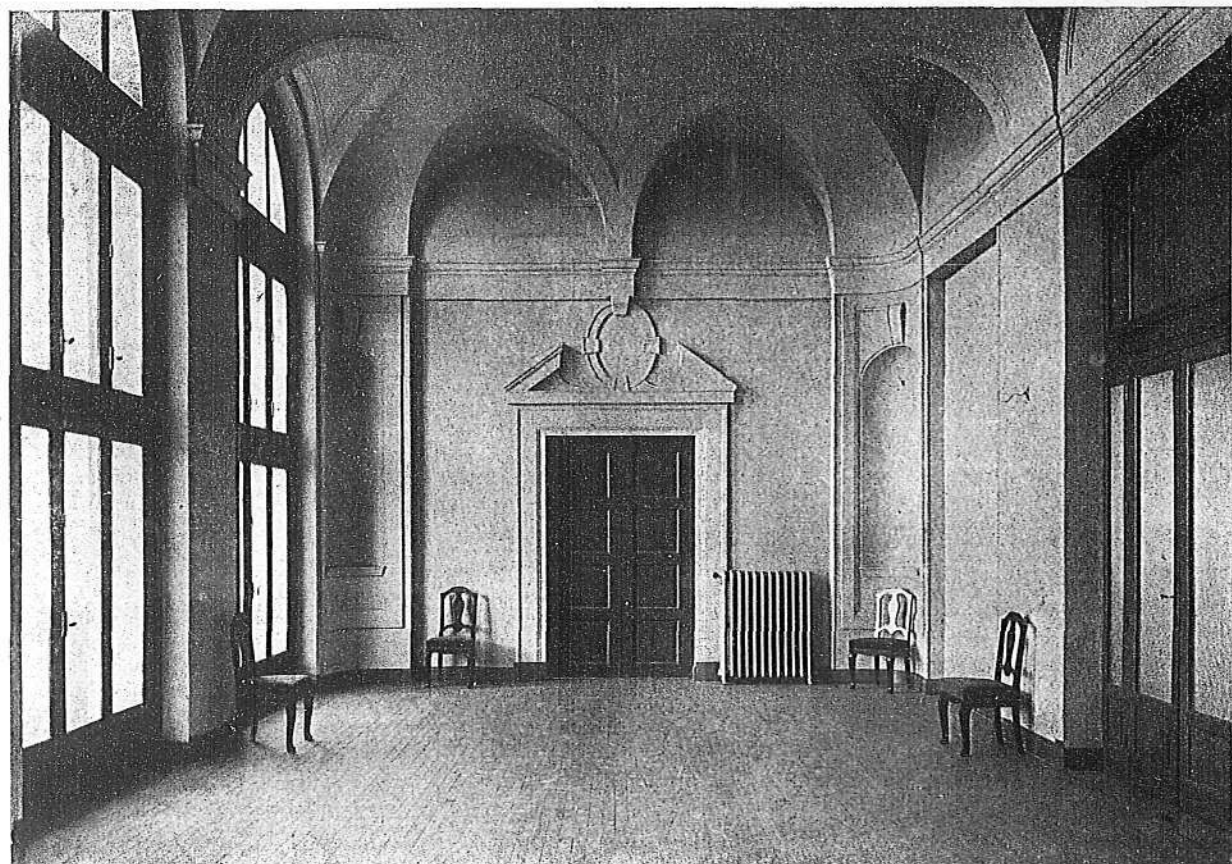

Casa de la Prensa, Madrid

Salón del torreón en el piso 15 y estudios para el mobiliario de la Asociación de la Prensa

The Press House, Madrid

Chamber of tower on 15th floor and studies of furnishing scheme of Press Association

PEDRO MUGURUZA, Arquitecto



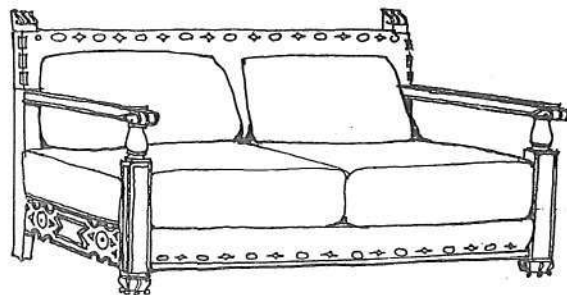
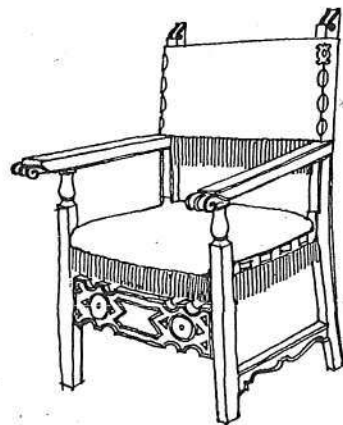
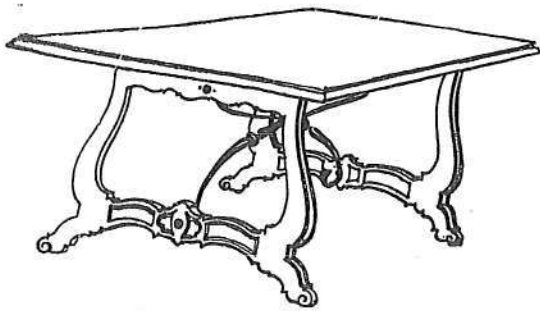
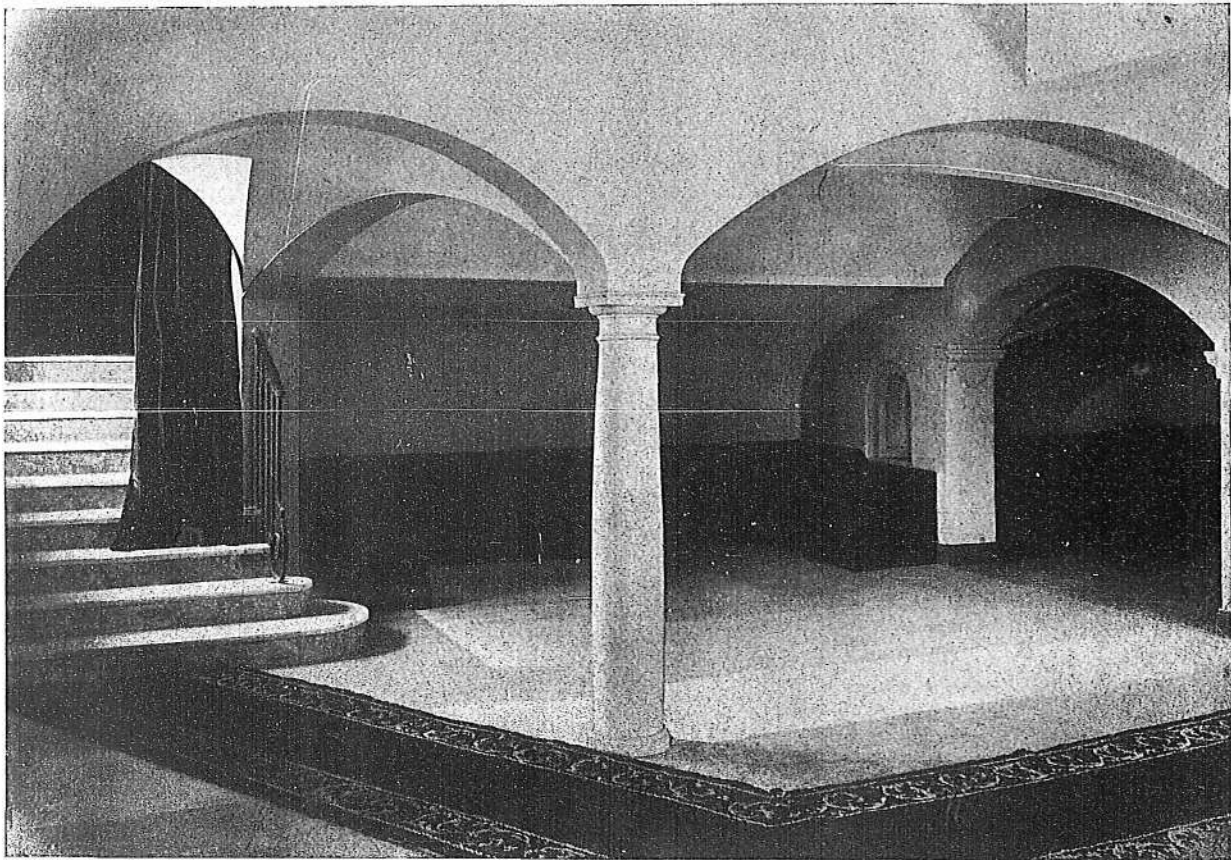

Casa de la Prensa, Madrid

Vestíbulo del Cinematógrafo y estudios de mobiliario para la
Asociación de la Prensa

The Press House, Madrid

Hall of Cinema and studies of furnishing scheme of Press
Association

PEDRO MUGURUZA, Arquitecto



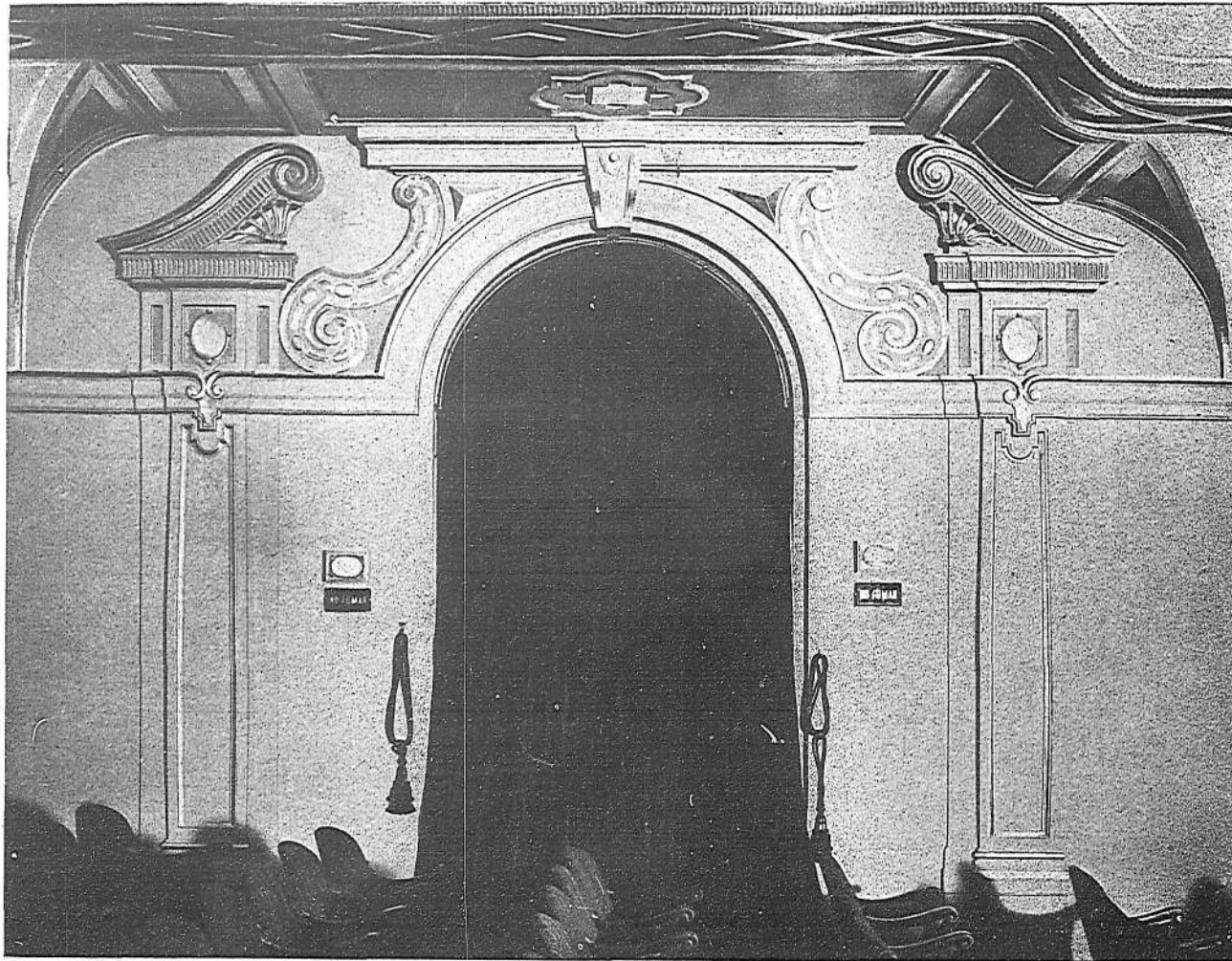

Casa de la Prensa, Madrid.
Detalles decorativos del interior de la Sala de Fiestas

PEDRO MUGURUZA, Arquitecto

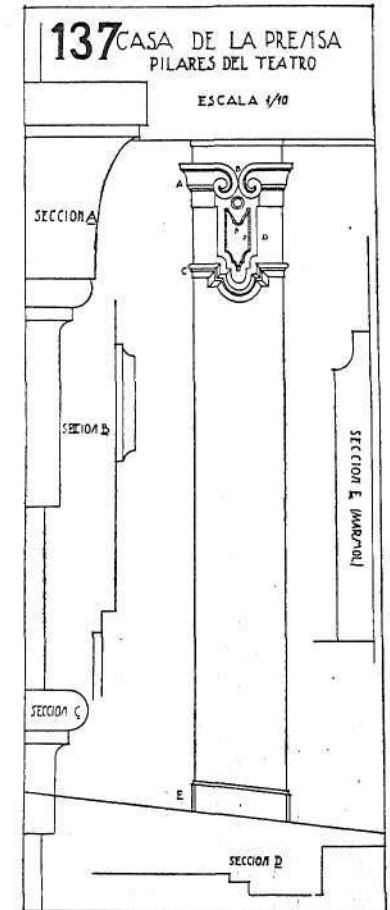

The Press House, Madrid
Decorative details of interior of Festival Hall



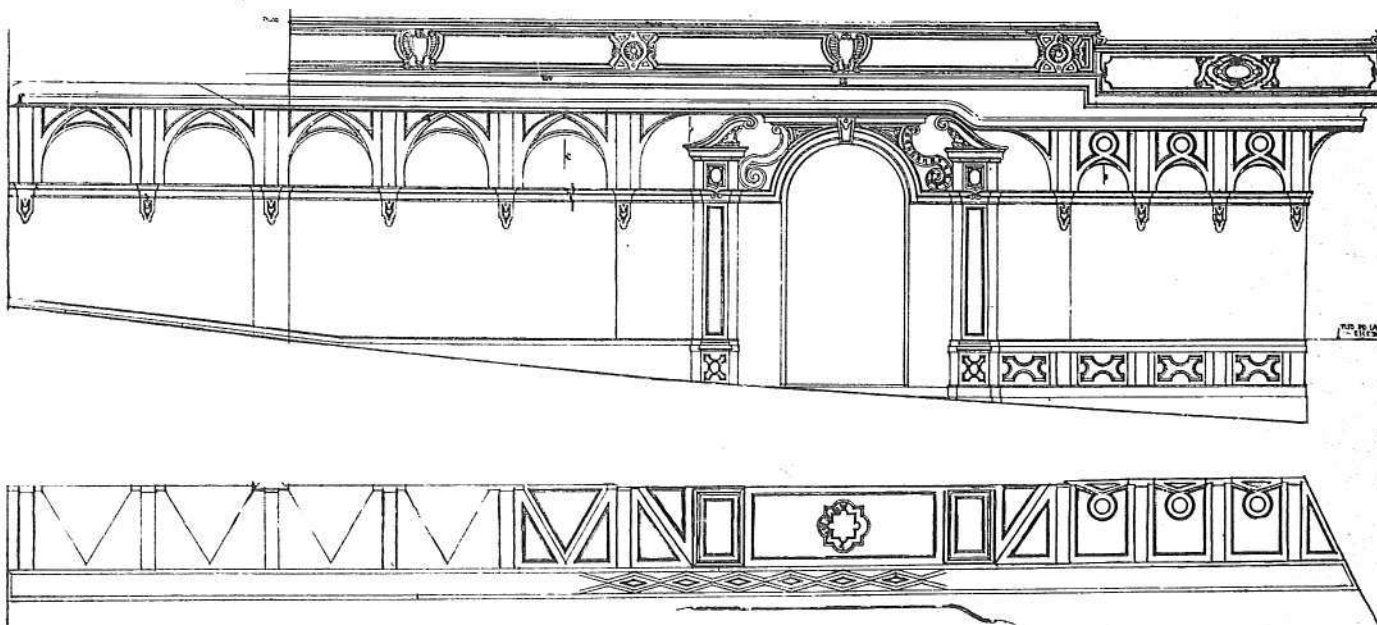
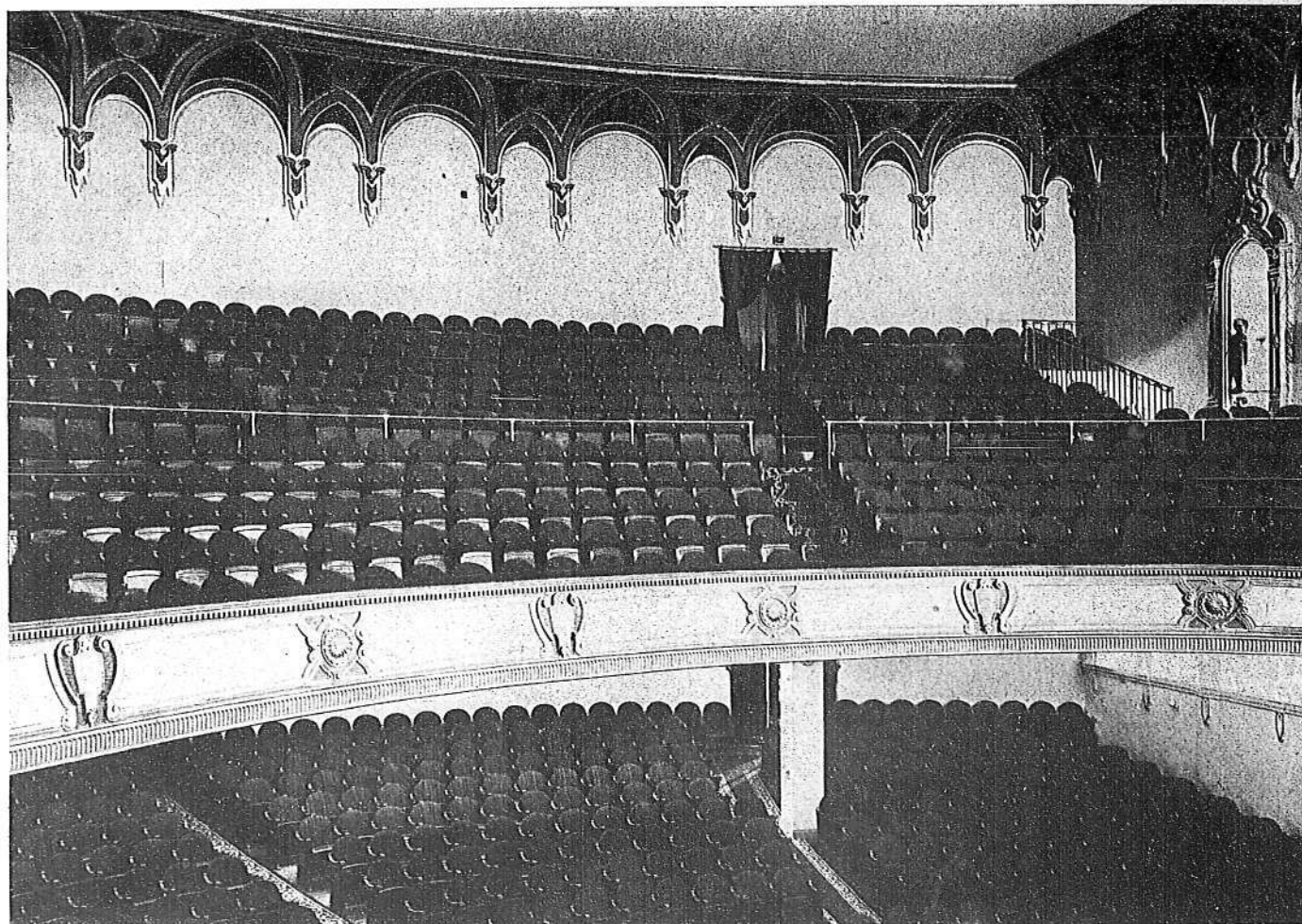

Casa de la Prensa, Madrid

The Press House, Madrid

Aspecto general de la Sala de Espectáculos y alzado lateral de su patio de butacas

General view of Entertainment Hall and side elevation of pit

PEDRO MUGURUZA, Arquitecto



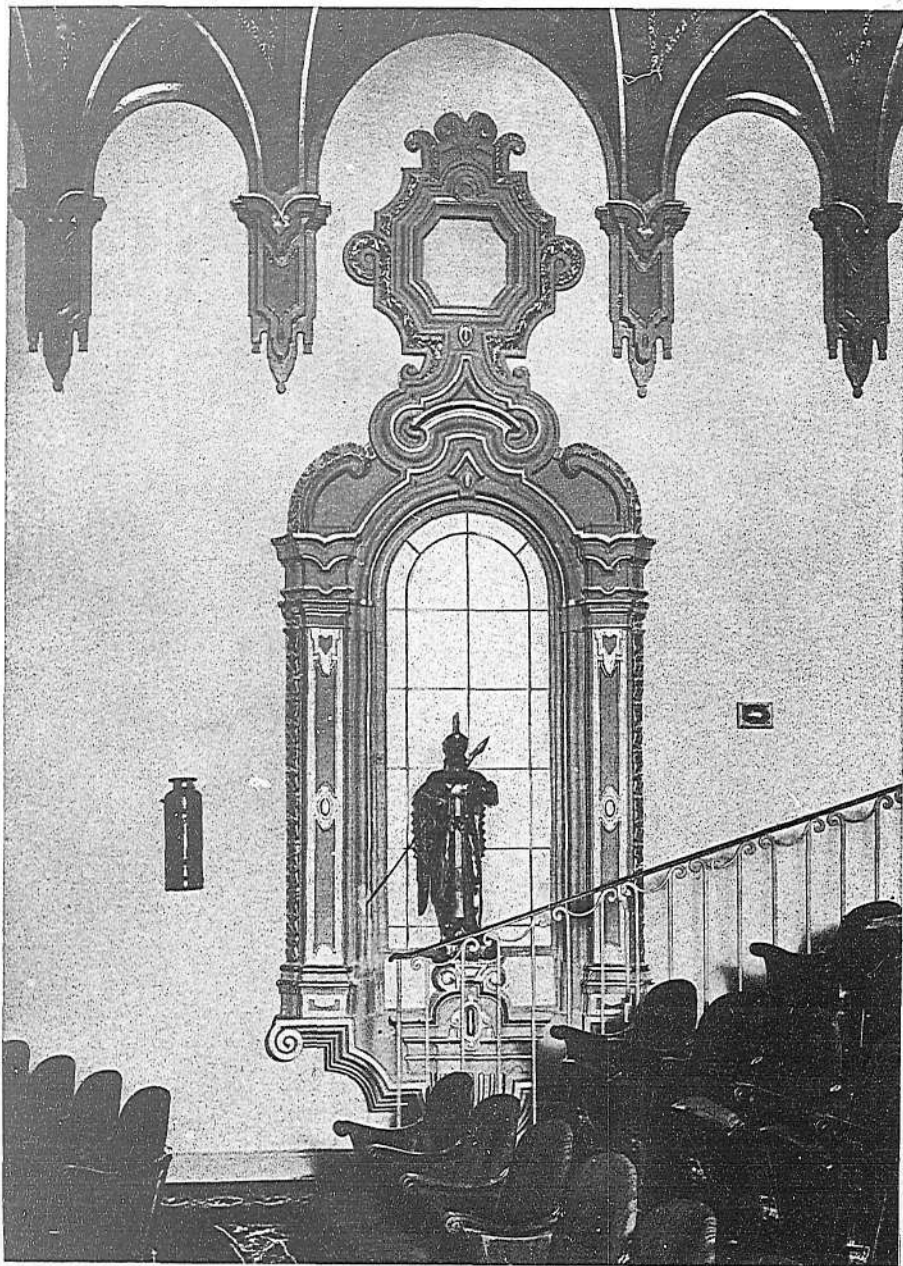

Casa de la Prensa, Madrid
Transparente del anfiteatro de la Sala de Fiestas

PEDRO MUGURUZA, Arquitecto
Ayuntamiento de Madrid

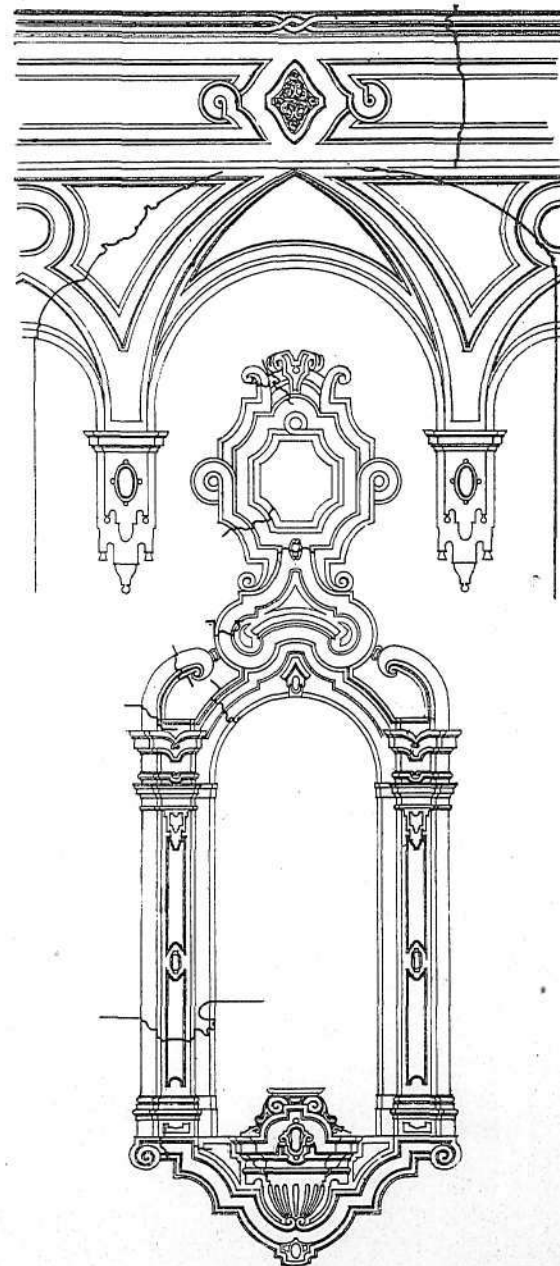

The Press House, Madrid
Window of amphitheatre of Festival Hall



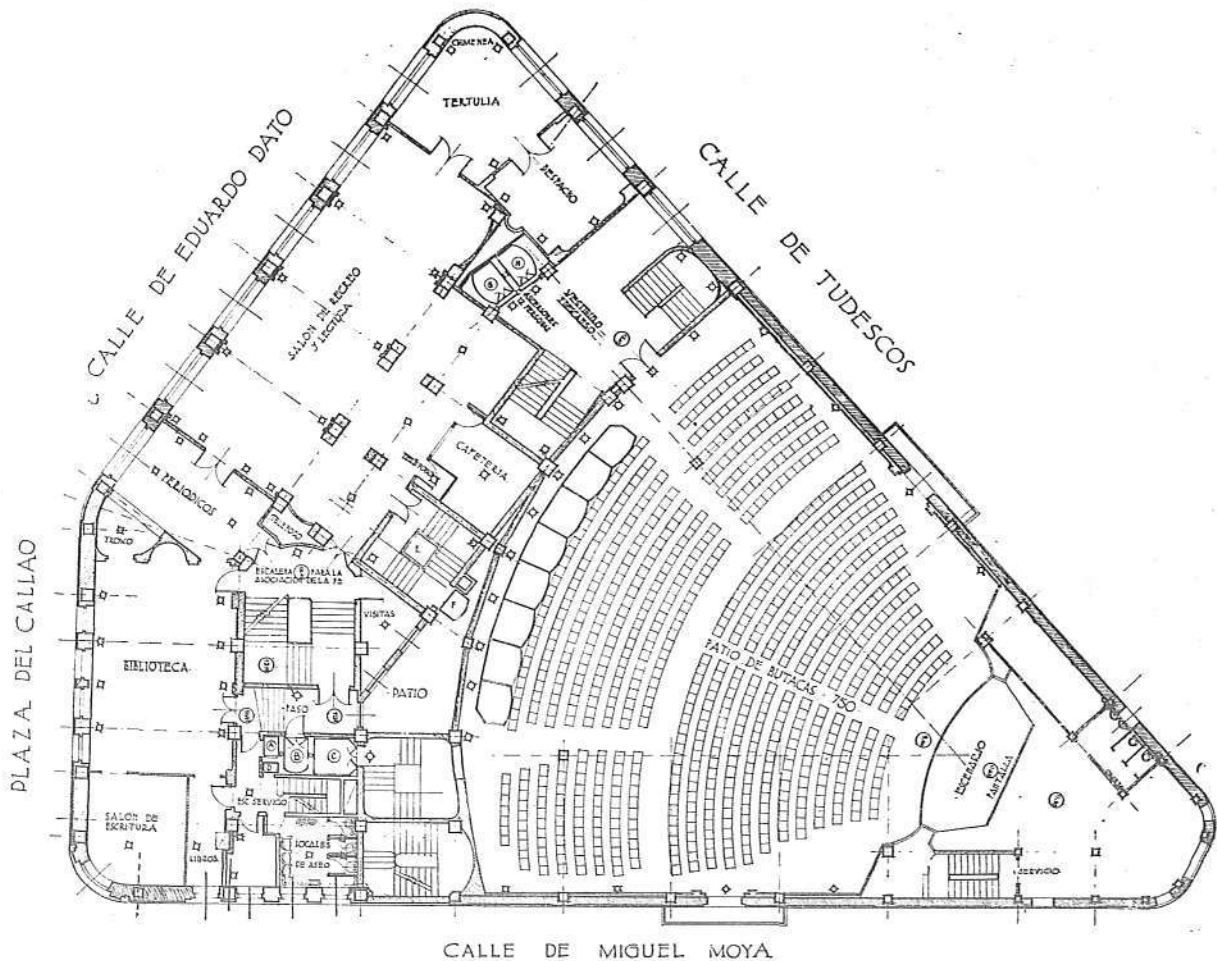
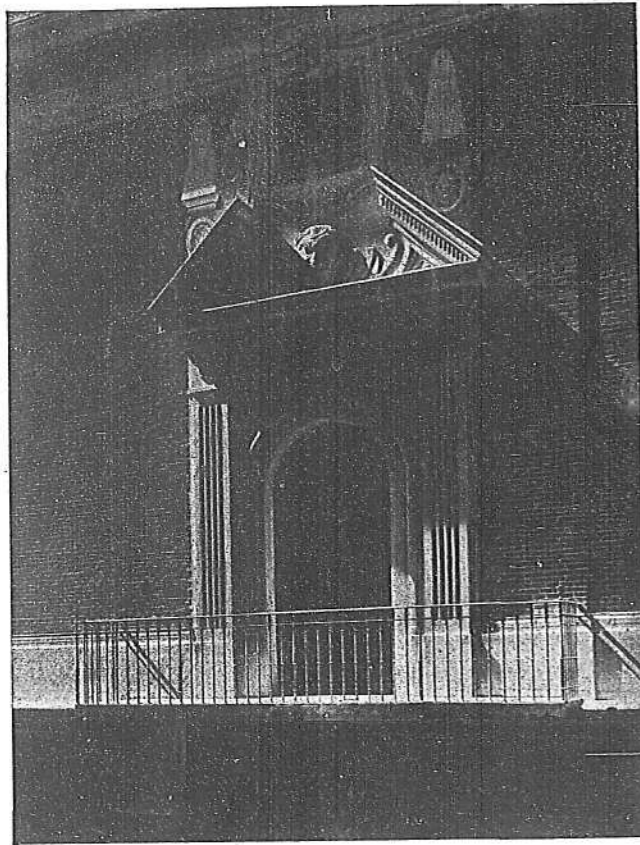

Casa de la Prensa, Madrid

Planta entresuelo y detalle de un balcón del Cinematógrafo en la calle de Miguel Moya

The Press House, Madrid

Ground plan, and detail of balcony of Cinema in the calle de Miguel Moya

PEDRO MUGURUZA, Arquitecto

Ayuntamiento de Madrid



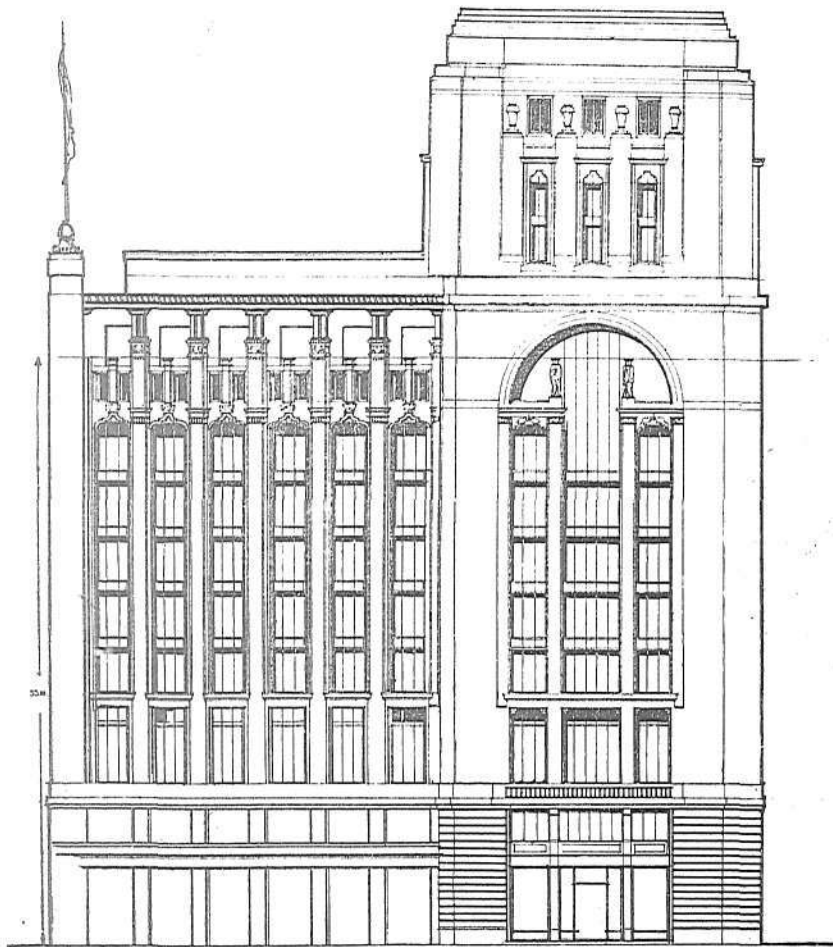

Casa de Prensa, Madrid
Estudios preliminares de la fachada principal

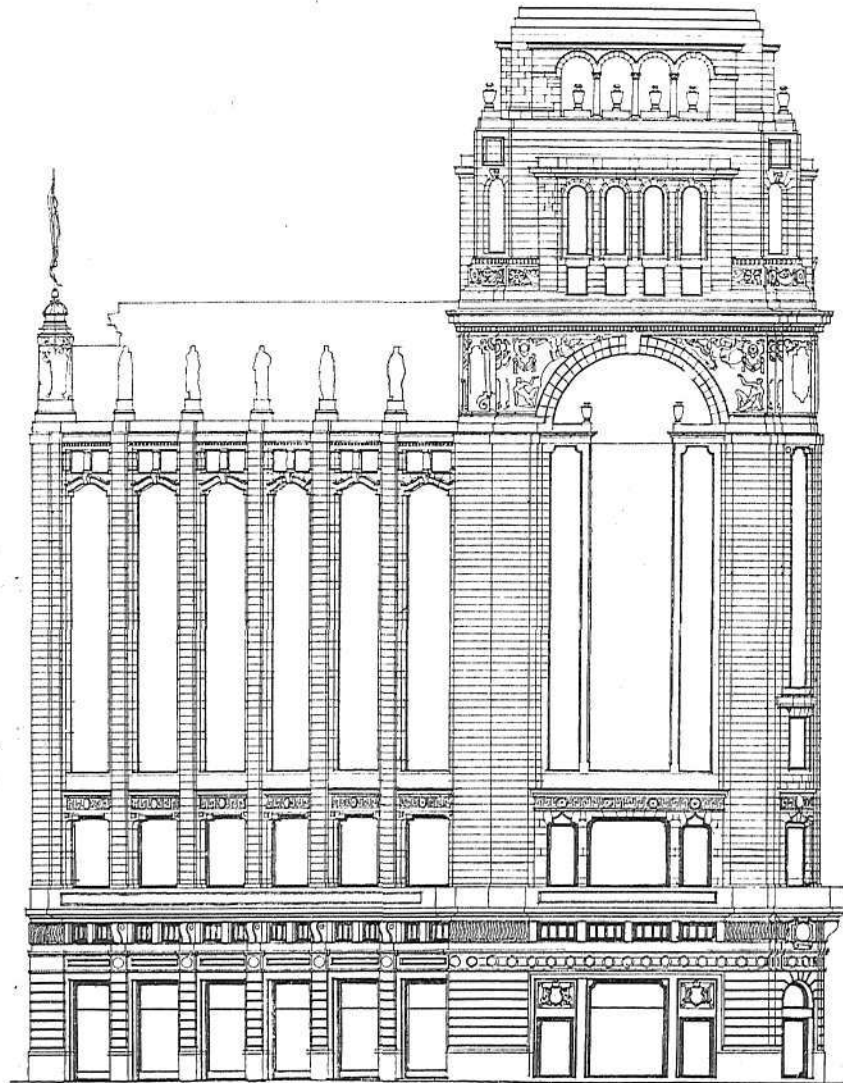

The Press House, Madrid
Preliminary studies of the main front

PEDRO MUGURUZA, Arquitecto





Casa de la Prensa, Madrid

Detalle de la fachada a la calle de Miguel Moya y plano de obra de carpentería

PEDRO MUGURUZA, Arquitecto

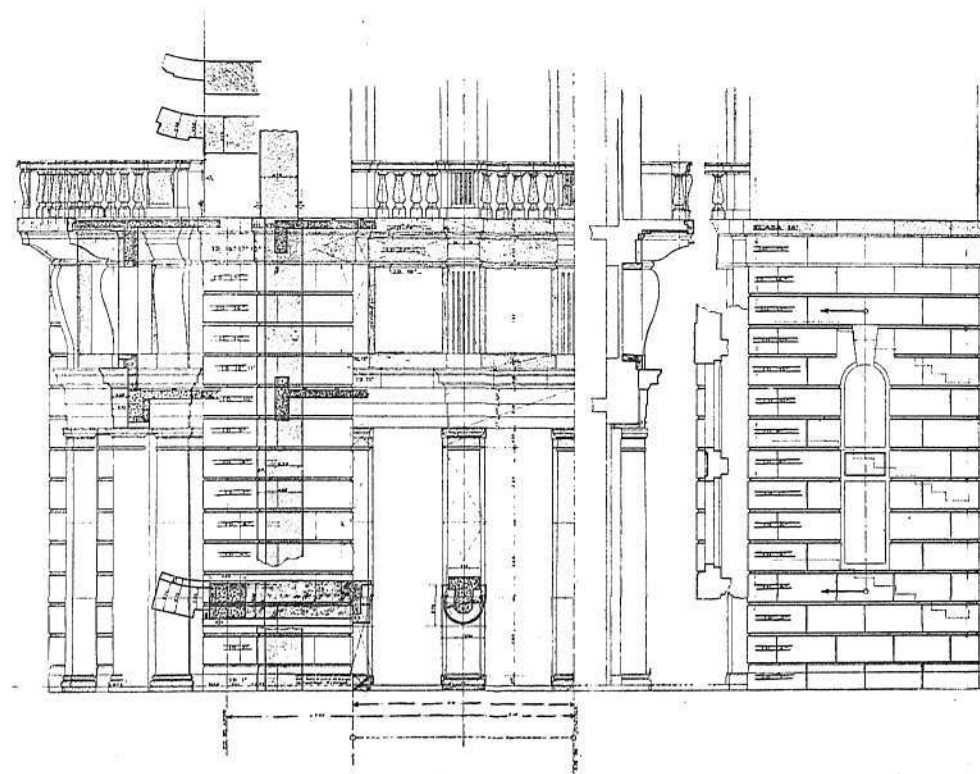

The Press House, Madrid

Detail of front facing the calle de Miguel Moya and plan of masonry





Casa de la Prensa, Madrid

Detalle del ángulo de las calles Eduardo Dato y Tudescos y detalle de carpintería

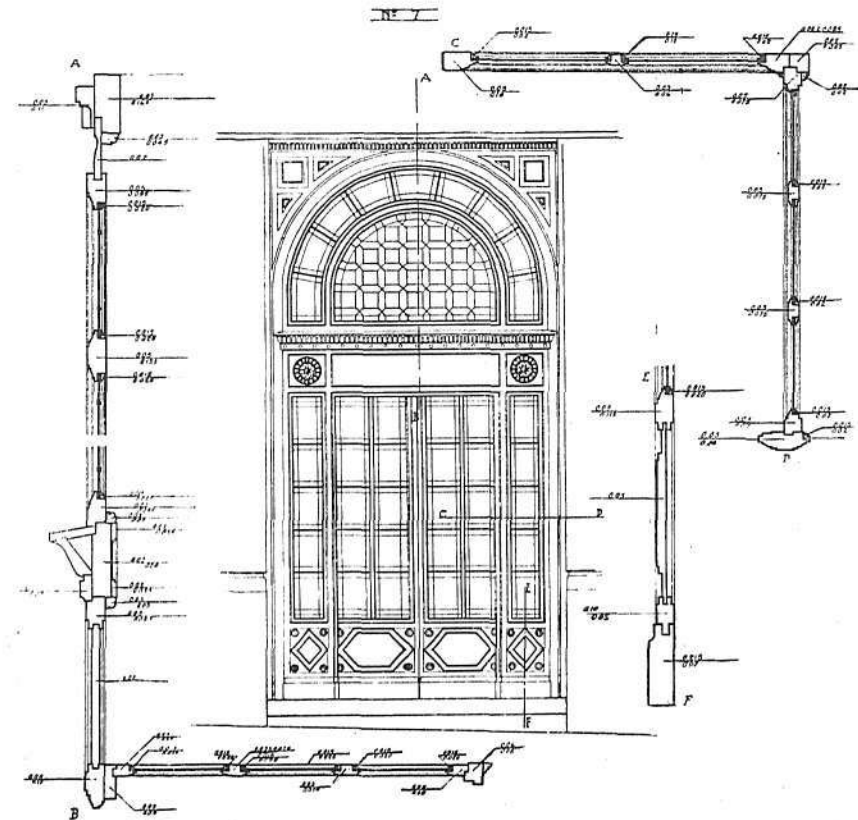

The Press House, Madrid

Detail of angle of the calle Eduardo Dato and calle Tudescos and detail of wood-work

PEDRO MUGURUZA, Architect



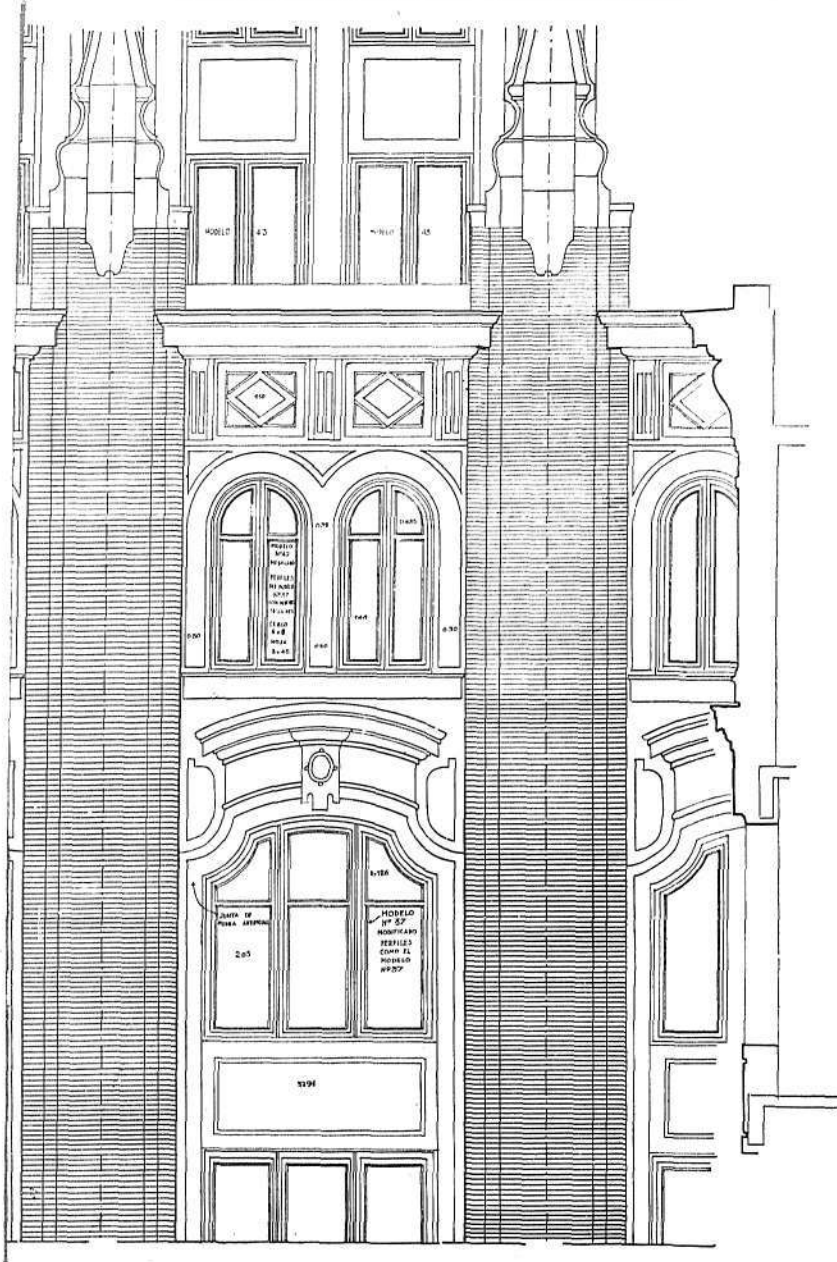

Casa de la Prensa, Madrid

Planos de obra correspondientes a los pisos 8, 9 y 10 en la fachada principal

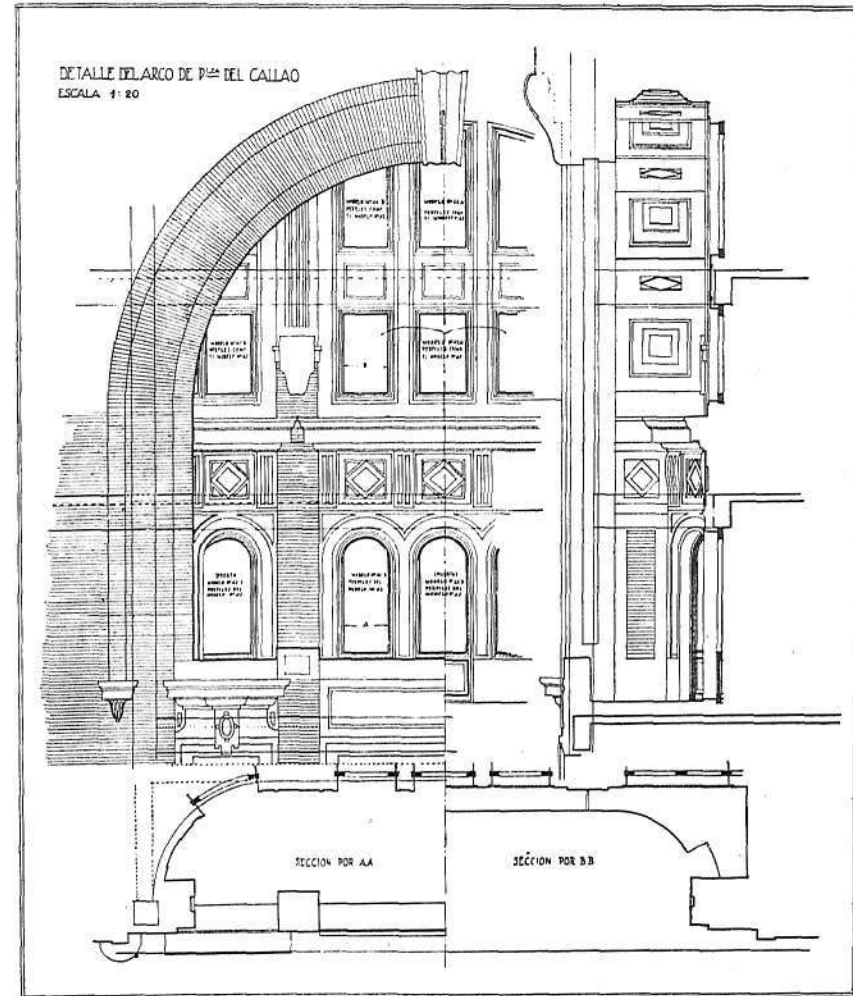

The Press House, Madrid

Working plans corresponding to 8th, 9th and 10th floors of main front

PEDRO MUGURUZA, Architect

Ayuntamiento de Madrid



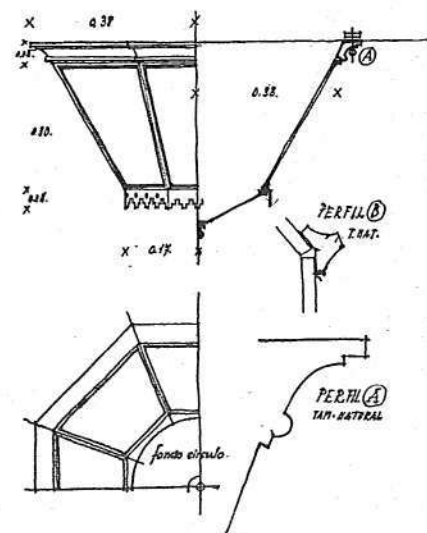
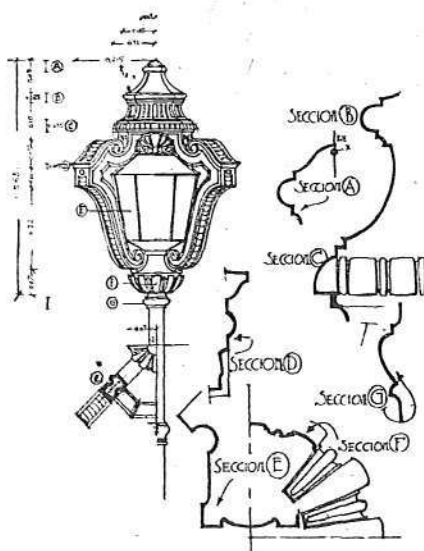
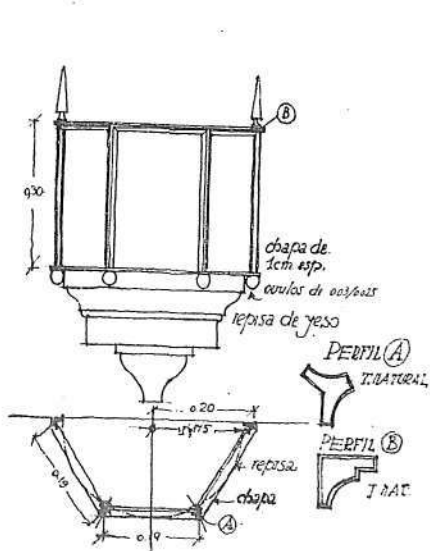
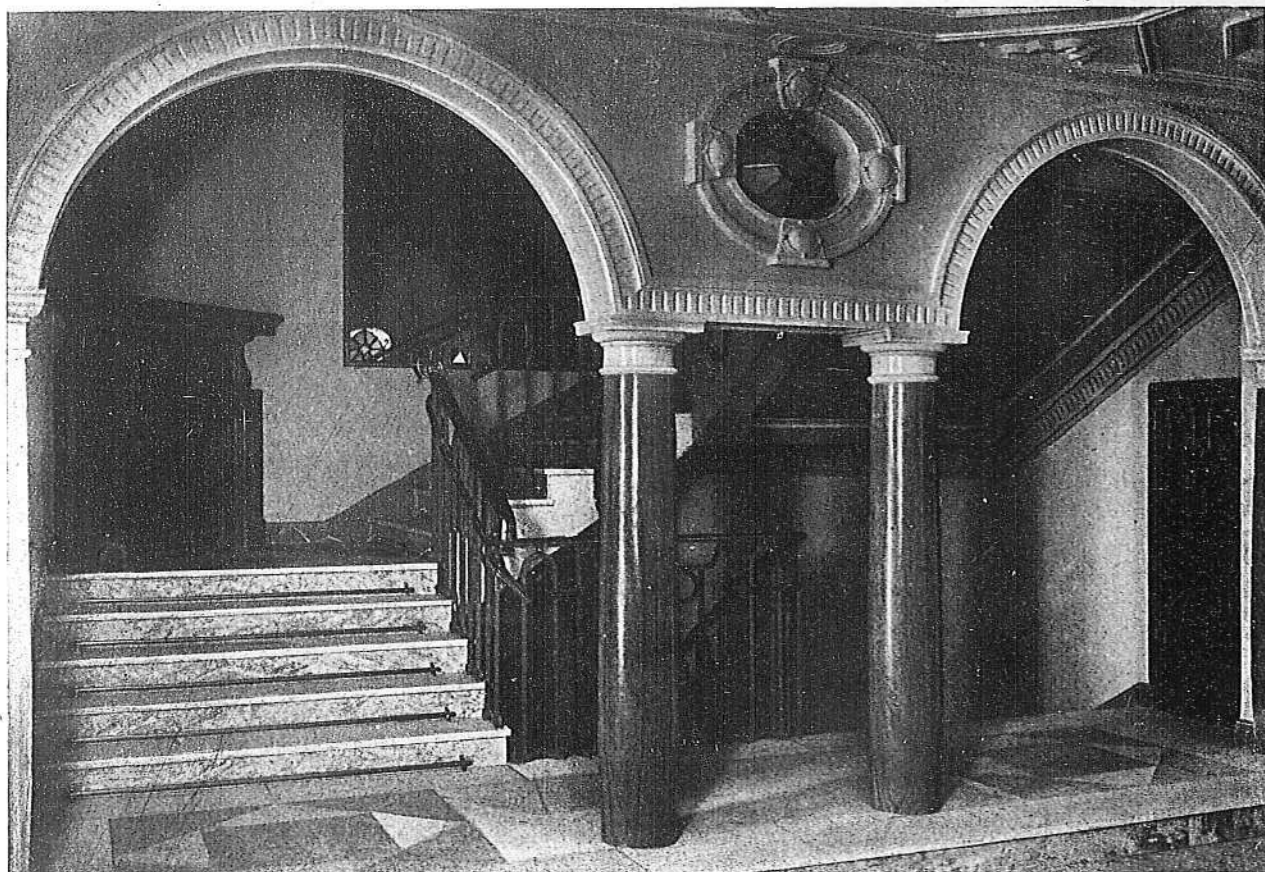

Casa de la Prensa, Madrid

Vestuario de la Asociación de la Prensa

Detalles de cerrajería: Farol de pared en el club; farol en el teatro
y farol de techo en el Club de Periodistas

The Press House, Madrid

Dressing-room of the Press Association

Details of lock-smith's art: Wall lamp in club; lamp in theatre
and ceiling lamp in Journalists' Club

PEDRO MUGURUZA, Arquitecto



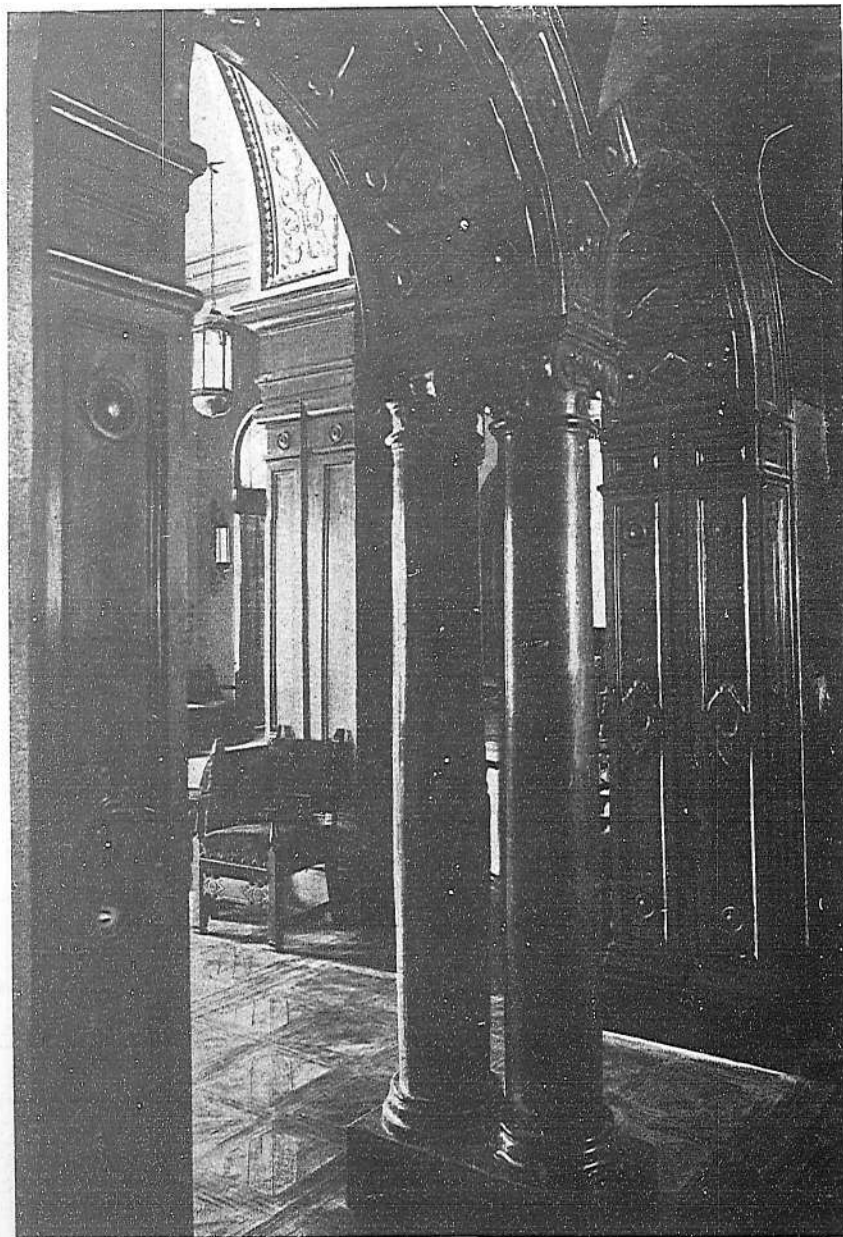

Casa de la Prensa, Madrid
Rincón de la Sala de Fiestas

Detalles de cerrajería: Farol en la Sala de Fiestas de la Asociación y farol en la escalera de la misma

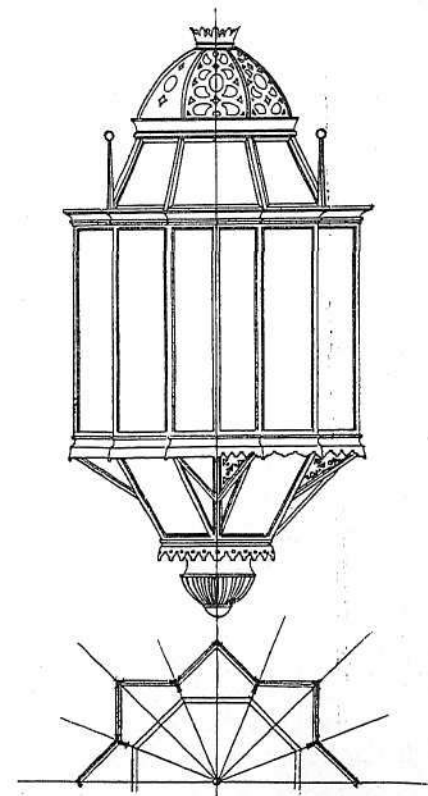
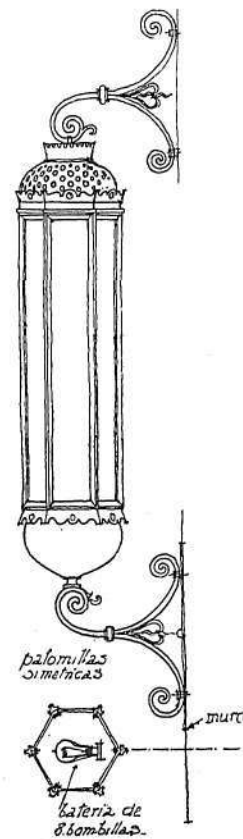

The Press House, Madrid
Corner of Festival Hall

Details of lock-smith's art: Lamp in Festival Hall of Association and lamp on staircase of same

PEDRO MUGURUZA, Architect

Ayuntamiento de Madrid



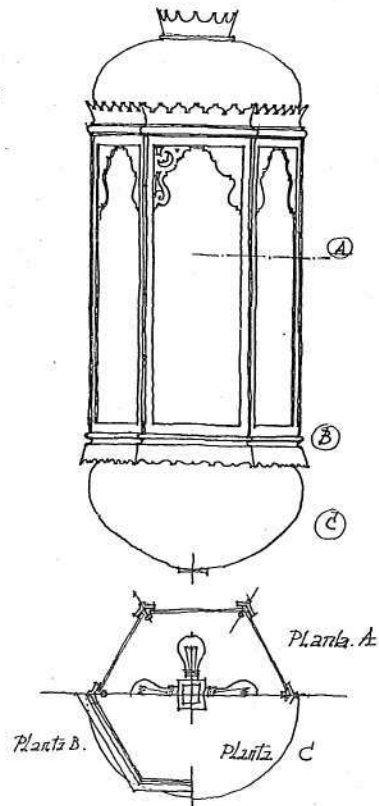
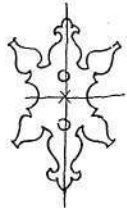
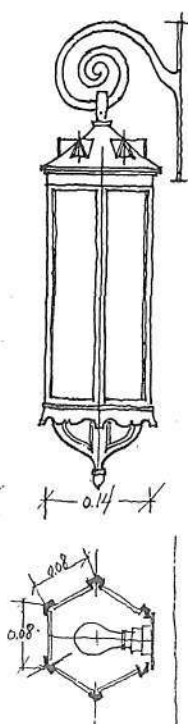
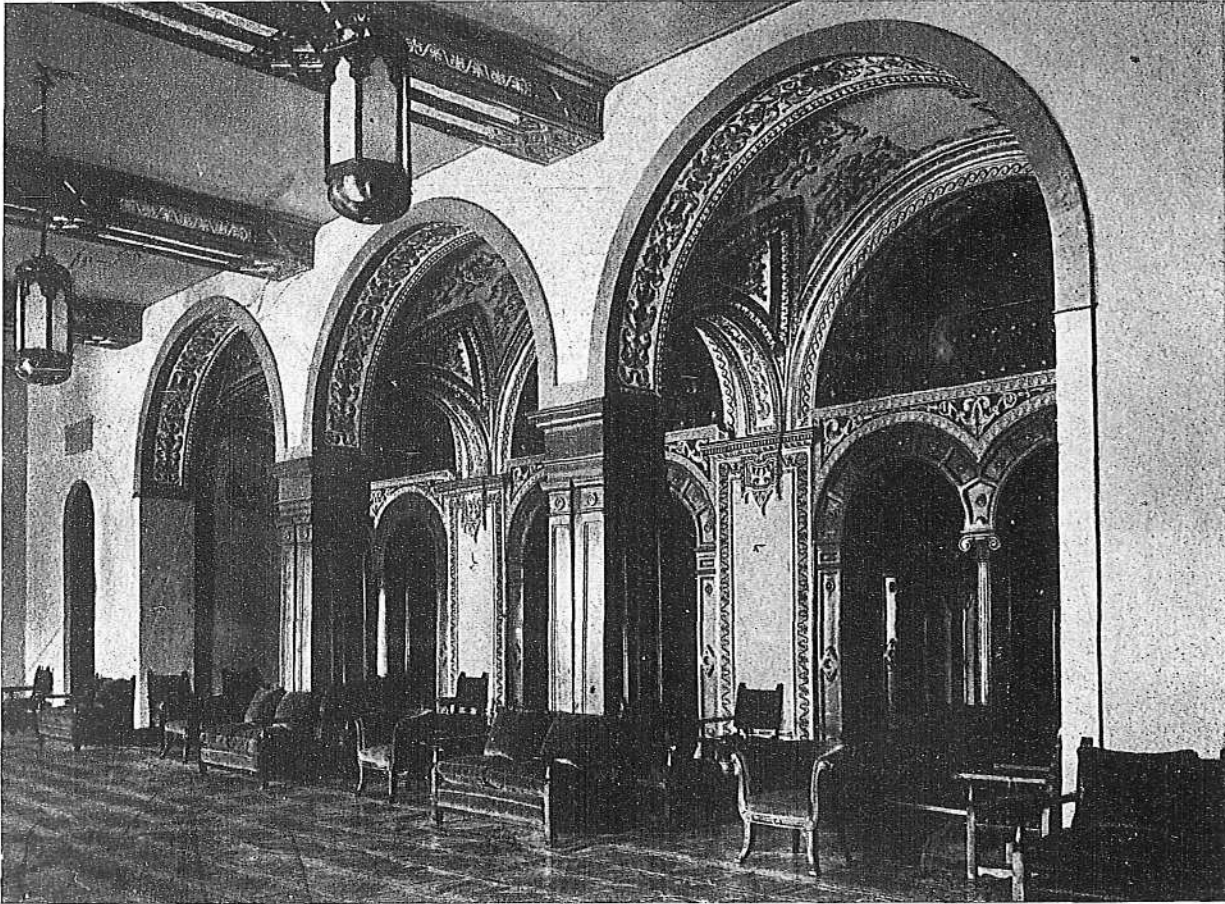

Casa de la Prensa, Madrid

Sala de Fiestas de la Asociación de la Prensa

Detalles de cerrajería: Faroles en el vestíbulo y Sala de Fiestas de la Asociación

PEDRO MUGURUZA, Arquitecto

The Press House, Madrid

Festival Hall of the Press Association

Details of lock-smith's art: Lamps in main hall and Festival Hall of Association

